

Miele

Operating Instructions

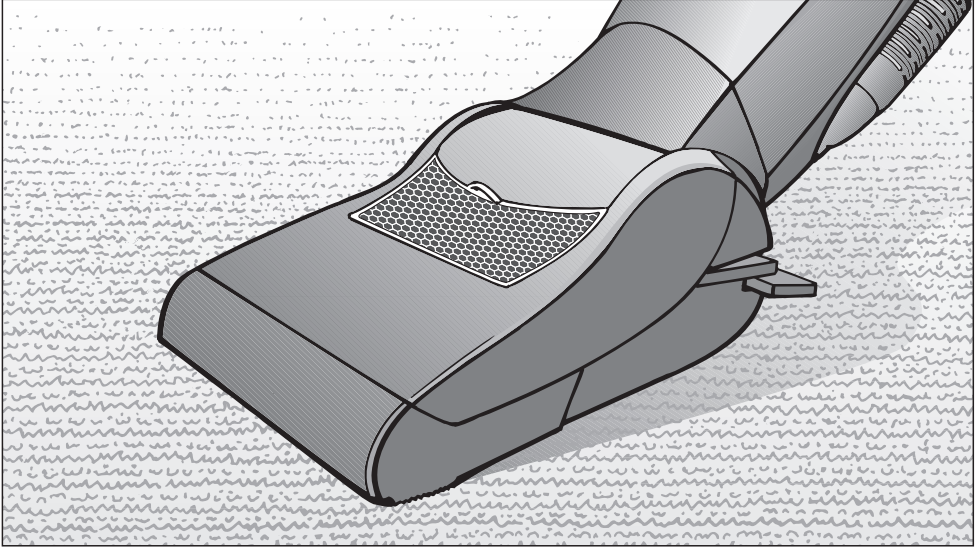

Upright Vacuum Cleaner

Dynamic U1

HS08

en - US

M.-Nr. 10 098 300

Only Miele FilterBags, filters and accessories with the "Original Miele" logo can be used with this vacuum. Only then can the suction power of the vacuum cleaner reach its optimum potential creating the best possible cleaning results.

USE OF NON-MIELE COMPONENTS MAY VOID THE WARRANTY.

 The use of FilterBags made of paper or a similar material, or FilterBags with a cardboard retaining plate can lead to serious damage to the vacuum cleaner and may void the warranty, just as with the use of FilterBags without the "Original Miele" logo.

The "Original Miele" Logo will appear on the packaging or directly on the FilterBag.

**ORIGINAL
Miele**



Purchasing new FilterBags and filters

Original Miele FilterBags and filters can be purchased from an authorized Miele vacuum dealer or by visiting the Miele store at www.mieleusa.com.

Guide to the vacuum cleaner	4
IMPORTANT SAFETY INSTRUCTIONS	6
Before the first use	9
Included accessories	9
Use	10
Power cord	10
Rewinding the power cord	10
Release the vacuum cleaner	10
Turning the vacuum cleaner On/Off	10
"Automatic" setting	11
Vacuum hose	12
Telescopic wand	12
Powerbrush	12
Turning the Powerbrush On/Off	13
Maintenance and care	13
Purchasing new FilterBags and filters	13
Which FilterBags and filters are the right ones?	14
When to change the FilterBag	14
Changing the FilterBag	15
When to change the dust compartment filter (pre-motor filter)	15
Changing the dust compartment filter	15
When to change the exhaust filter	15
Replacing the "AirClean" filter	16
Replacing the "Active AirClean 30" filter and the "HEPA AirClean 30" filter	16
Exchanging exhaust filters	16
Service indicator with reset button	17
Removing hair and threads from the Powerbrush	17
Blockages	17
Cleaning and care	18
Frequently asked questions	18
After sales service	19
Optional accessories	19
Caring for the environment	20
LIMITED WARRANTY - VACUUM CLEANERS USA	21

Guide to the vacuum cleaner

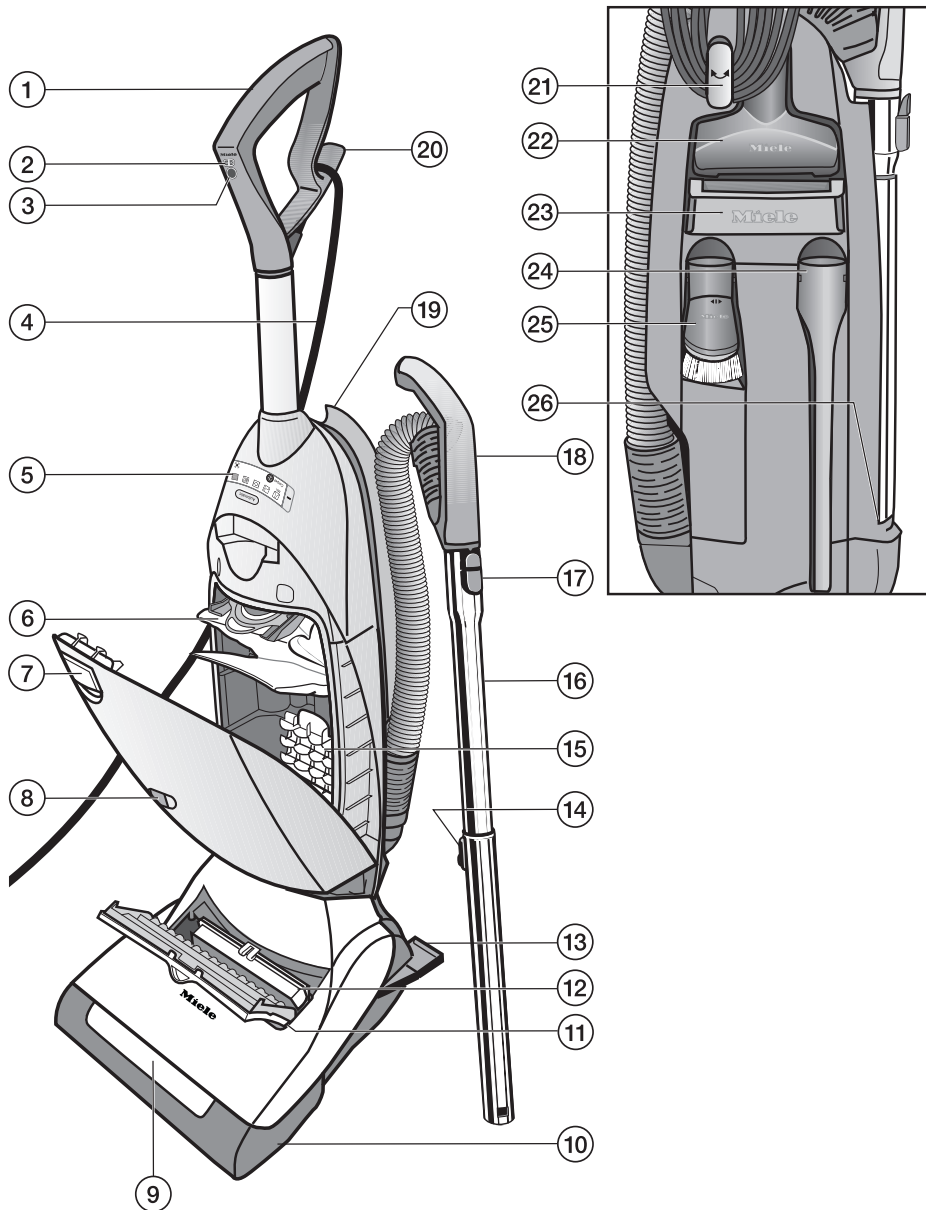

The illustration shows the vacuum cleaner with all available options. Options vary depending on model.

- ① Hand piece
- ② On/Off switch
- ③ Carpet/Floor Powerbrush selector
- ④ Power cord
- ⑤ Control panel
- ⑥ FilterBag
- ⑦ Dust compartment lid release
- ⑧ Airflow indicator
- ⑨ Headlight *
- ⑩ Powerbrush
- ⑪ Exhaust filter compartment
- ⑫ Exhaust filter *
- ⑬ Foot pedal to recline vacuum
- ⑭ Telescopic wand release button
- ⑮ Dust compartment filter (pre-motor filter)
- ⑯ Telescopic wand
- ⑰ Release button
- ⑱ Vacuum hose with handle
- ⑲ Hose clip
- ⑳ Power cord hook (upper)

The features marked * may vary or not be available on your model.

Back of vacuum cleaner

- ㉑ Adjustable power cord hook (lower)
- ㉒ Upholstery tool
- ㉓ Carrying handle
- ㉔ Crevice nozzle
- ㉕ Dust brush
- ㉖ Bracket for telescopic wand

IMPORTANT SAFETY INSTRUCTIONS

When using an electrical appliance, basic precautions should always be followed, including the following:

READ ALL INSTRUCTIONS BEFORE USING THIS APPLIANCE

WARNING-

To reduce the risk of fire, electric shock or injury:

Before using

▶ Check the voltage rating of the vacuum cleaner before connecting the power cord to an electrical outlet. The power source should correspond with the voltage rating plate of the vacuum cleaner. Use only household AC outlets. Never use DC power sources. If you are not sure of your home's voltage supply, consult a qualified electrician. Connecting the vacuum cleaner to a higher voltage may result in damage or injury.

▶ To reduce the risk of electric shock, this appliance has a polarized plug (one blade is wider than the other). This plug will fit in a polarized outlet only one way. If the plug does not fit fully in the outlet, reverse the plug. If it still does not fit, contact a qualified electrician to install the proper outlet. Do not alter the plug in any way.

▶ The electrical outlet must be fitted with a 15 A fuse.

▶ A damaged vacuum cleaner can be dangerous. Check the packaging, vacuum cleaner and accessories for any signs of damage. Do not use a damaged appliance.

▶ Do not use with a damaged cord or plug. If the appliance is not working as it should, has been dropped, damaged, left outdoors or submerged in water, bring it to a service center.

IMPORTANT SAFETY INSTRUCTIONS

Use

- ▶ Do not use on people or animals.
- ▶ Do not use outdoors or on wet surfaces. Only **dry** surfaces should be vacuumed.
- ▶ Use only as described in this manual with Miele recommended accessories.
- ▶ This appliance is intended for household use only.
- ▶ Do not allow the vacuum cleaner to be used as a toy. Close attention is necessary when used near children.
- ▶ Be aware, the cord clip can become loose over time. Do not allow children to come in contact with this small part. Choking hazard.
- ▶ Never use the vacuum cleaner without the dustbag or filters in place. It may cause damage.
- ▶ If a dustbag is not inserted, the dust compartment lid will not close. Do not force it shut.
- ▶ Do not leave the vacuum cleaner plugged in. Unplug it from the outlet when not in use and before servicing.
- ▶ This vacuum cleaner should not be used to entrap or retain any hazardous materials.
- ▶ Do not use the vacuum cleaner to pick up liquids or damp dirt. This could impair the electrical safety of the vacuum cleaner. Wait for freshly shampooed carpets to dry.
- ▶ Do not vacuum anything that is burning or smoking such as cigarettes, matches or hot ashes. The vacuum cleaner could catch fire.
- ▶ Do not vacuum toner dust. Toner, such as that used in printers and photocopiers, can conduct electricity.
- ▶ Do not vacuum flammable or combustible liquids, such as gasoline, or use in areas where they may be present.
- ▶ Do not vacuum items which are heavy, hard or have sharp edges. They could cause a blockage and damage the appliance.
- ▶ Do not pull or carry by the cord, use the cord as a handle, close a door on the cord, or pull the cord around sharp edges or corners. Do not run the appliance over the cord. Keep the cord away from heated surfaces.
- ▶ Do not unplug the vacuum cleaner by pulling on the cord. To unplug, grasp the plug, not the cord.
- ▶ Do not handle the plug or vacuum cleaner with wet hands.
- ▶ Keep the power cord, hair, loose clothing, fingers and other parts of the body away from openings and moving parts.
- ▶ Do not place anything into the openings of the vacuum cleaner. Do not use if any openings are blocked; keep them free of dust, lint, hair, or anything that may reduce air flow.

IMPORTANT SAFETY INSTRUCTIONS

- ▶ Turn off all controls before unplugging.
- ▶ Use extra care when cleaning on stairs.
- ▶ The hose, wand and accessories must not be used at head level to avoid injury to eyes and ears.
- ▶ Monitor the airflow indicator and inspect all filters regularly. For best performance, the FilterBags and filters should be replaced when necessary. A full bag or blocked filter will reduce the vacuum cleaner's suction power. A temperature limiter automatically switches the vacuum cleaner off if it gets too hot, see "Frequently asked questions".

Using accessories

- ▶ Unplug the vacuum cleaner when changing accessories.
- ▶ To avoid the risk of injury when vacuuming do not touch the beater bar. Danger of injury.
- ▶ Do not use the vacuum hose or telescopic wand without an accessory attached. The rim could be damaged and injuries could result from sharp edges.
- ▶ Miele FilterBags are disposable and intended to be used only once. Do not attempt to reuse them. An over stuffed FilterBag will reduce the efficiency of the vacuum cleaner.
- ▶ Only use genuine Miele FilterBags with the Miele quality signet and original Miele filter and accessories. Only then can the manufacturer guarantee its safety.

Cleaning, maintenance and repairs

- ▶ Turn the vacuum cleaner off after each use and before every cleaning/maintenance. Pull the plug from the outlet.
- ▶ Never submerge the vacuum cleaner in water. Clean only with a dry or slightly damp cloth when disconnected from the mains supply. If moisture gets into the appliance there is a risk of electric shock.
- ▶ Repairs must only be performed by an authorized service agent in accordance with national and local safety regulations. Repairs by unqualified persons could be dangerous. The manufacturer cannot be held responsible for unauthorized work.
- ▶ If the power cord is damaged it should be replaced with a genuine Miele cord by Technical Service.

Disposing of an old appliance

- ▶ Before discarding an old vacuum cleaner, please cut off the power cord and render the plug useless. Ensure the appliance presents no danger to children while being stored for disposal.

SAVE THESE INSTRUCTIONS

ONLY MIELE FILTERBAGS, FILTERS AND ACCESSORIES WITH THE “ORIGINAL MIELE” LOGO CAN BE USED WITH THIS VACUUM CLEANER. USE OF NON-MIELE COMPONENTS MAY VOID THE WARRANTY.

The illustrations referred to in the text are shown on the fold-out pages at the end of these operating instructions.

Before the first use

Assembly (see fig. 1)

- Put the vacuum cleaner in an upright position.
- Push the handle down into the body of the vacuum cleaner until it engages (see illustration).

Activating the exhaust filter change indicator (see fig. 2-6)

Depending on the model, one of the following standard exhaust filters is installed (see fig. 2).

- a** AirClean Filter
- b** Active AirClean Filter SF-AA 30 (black)
- c** HEPA AirClean Filter SF-HA 30 (white)

If your vacuum cleaner is equipped with a type **b** or **c** exhaust filter, you will need to activate the exhaust filter change indicator.

- Open the lid of the exhaust filter compartment and slightly pull the exhaust filter out of its slot (see fig. 3).
- Remove the marker strip and then reinsert the exhaust filter (see fig. 4).

- Press the exhaust filter change indicator ► (see fig. 5).
- After about 10-15 seconds, a small red marker will appear in the left-hand side of the display (see fig. 6).
- Close the lid of the exhaust filter compartment.

How the exhaust filter change indicator works (see fig. 7).

The exhaust filter change indicator displays the useful life of the exhaust filter. The indicator will turn fully red after approx. 50 hours of operation, which is equivalent to one year of average use.

Included accessories (see fig. 8)

The following accessories are mounted on the rear of the vacuum cleaner.

- ① Upholstery tool
- ② Crevice nozzle, 12" (300 mm)
- ③ Dust brush with natural bristles

Attach the accessory you wish to use to the handle on the vacuum hose or the telescopic wand.

Upholstery tool

For cleaning upholstery, mattresses, cushions, draperies, etc.

Crevice nozzle, 12" (300 mm)

For cleaning folds, crevices, corners and tight spaces.

Dust brush with natural bristles

For cleaning moldings, ornate and carved articles, delicate items, etc.

The brush head can be turned to attain the optimal cleaning position.

Use

Power cord (see fig. 9)

The lower cord hook can be rotated.

- Rotate the hook upward to release the power cord.

Rewinding the power cord (see fig. 10)

When the vacuum cleaner is not in use, the power cord can be wound around the two cord hooks.

- To prevent the cord from unwinding press it into the locking groove of the plug (see insert).

Plug in the vacuum cleaner (see fig. 11)

- Guide the power cord through the notch at the side and over the upper cord hook (see illustration).

This will keep the cord in an optimal position so that it will not interfere with vacuuming. It also keeps the power cord from becoming caught in the handle.

Release the vacuum cleaner (see fig. 12)

- Briefly press the foot pedal and recline the body of the vacuum cleaner to a comfortable position.

Turning the vacuum cleaner On/Off (see fig. 13)

Always follow the flooring manufacturer's cleaning and care instructions.

- Press the On/Off button on the handle.

The vacuum cleaner turns on.

ComfortLine Models:

The "On" indicator on the control panel lights yellow.

PremiumLine Models:

The suction power levels on the control panel light yellow.

Lighting (depending on model)

The headlight turns on automatically.

Control panels

Depending on the model, your vacuum cleaner will include one of the following control panels.

ComfortLine Models (see fig. 14)

- ① Vacuum "On" indicator
- ② Operation/Blockage protection indicator
Yellow: the Powerbrush was turned on using the Carpet/Floor button on the hand piece.
Red: the beater bar is blocked

- ③ Rotary selector

Selecting the suction power setting

You can adjust the suction power to suit your preference.

Rotary selector (see fig. 15)







- Turn the suction power selector to the desired setting.

PremiumLine Models (see fig. 16)

- ① "Automatic" button
- ② +/- controls, to set the desired suction power setting
- ③  "Thermo" indicator
- ④ Blockage protection indicator
- ⑤ Service indicator (reset button)
- ⑥ "Carpet" indicator, the Powerbrush was turned on using the Carpet/Floor button on the hand piece.

+/- Controls (see fig. 17)

The symbols on the control panel indicate what each setting is recommended for:

-  curtains, lightweight fabrics
-  upholstery, cushions
-  thick pile carpets, rugs and runners
-  energy saving, daily vacuuming with low noise level
-  low pile carpets
-  hard flooring and intensive cleaning of carpets.

- To select a higher power setting, press the + button.
- To select a lower power setting, press the - button.

The selected power level is displayed with a yellow light.

"Automatic" setting (see fig. 18)

(models with +/- controls)

If the "Automatic" setting is selected, the vacuum cleaner will automatically adjust the suction power level to suit the surface being cleaned.

- Press the "Automatic" button.

The button lights yellow.

To deactivate the setting, press the "Automatic" button again.

 Do not use this setting to vacuum draperies or other lightweight fabrics. Excessive suction may cause damage.

Note (see fig. 19):

To adjust to changing floor heights, e.g. carpet edges, thresholds, etc., briefly step on the release button to raise the front of the vacuum cleaner.

Vacuum hose (see fig. 20 + 21)

 Do not use the vacuum hose or wand at head level. Injury can occur.

Do not use the vacuum hose or telescopic wand without an accessory attached. The rim could be damaged and injuries could result from sharp edges.

When vacuuming stairs, ensure that the vacuum is placed on a lower step. Risk of injury.

- Place the vacuum in an upright position.
- Press the release button on the telescopic wand and pull the vacuum hose handle upwards.
- To increase the stability of the vacuum cleaner, slip the elbow over the vacuum hose so it engages.

For regular vacuuming, you will need to snap the handle back into the telescopic wand and place the wand back into the bracket (see the upper illustration).

Telescopic wand (see fig. 22 + 23)

- Place the vacuum in an upright position.
- To unhook the telescopic wand from the bracket, pull upward on the handle.
- To increase the stability of the vacuum cleaner, slip the elbow over the vacuum hose so it engages (see fig. 21).

The telescopic wand is composed of two interlocking tubes that can be adjusted to the desired length.

- Press the telescopic wand release button (see arrow) to release the tubes and adjust to the desired height.

To store the wand, adjust the tubes to the shortest length and place it back into the bracket (see the upper illustration).

Powerbrush**Recommended use**

Always follow the flooring manufacturer's cleaning and care instructions.

The Powerbrush is particularly suitable for cleaning and restoring crushed carpet pile of wall to wall carpeting and floor coverings subject to hard wear, especially in high traffic areas.

 Do not use the Powerbrush to vacuum high quality, hand knotted rugs, for example Berber or Persian rugs, as well as extremely long piled area rugs and carpets, e.g. shag. There is a danger of the threads being pulled out. Turn the Powerbrush off to vacuum these types of floor coverings and use only low suction power.

 Do not use the Powerbrush on floors with a variable or uneven surface. The brush could come in contact with the floor and cause damage.

Turning the Powerbrush On/Off (see fig. 24)

The beater bar in the Powerbrush is driven by a separate motor, which can be switched on and off.

- Press the "Carpet/Floor" button on the handle.

The Powerbrush turns on. The indicator on the control panel lights yellow.

You can also use the button to switch off the Powerbrush while vacuuming, for example when moving from carpet to hard floors.

The Powerbrush automatically shuts off anytime the body of the vacuum cleaner is placed into the full upright position.

- For best results, move the Powerbrush slowly back and forth over the area you wish to clean.

Maintenance and care

 Turn off and unplug the vacuum cleaner before performing any maintenance work.

The Miele filter system consists of the following three components.

- FilterBag
- Exhaust filter
- Dust compartment filter

Each of these components must be changed periodically to maintain the vacuum cleaner's efficiency.

Only use Miele FilterBags, filters and accessories with the "Original Miele" logo. Only then can the suction power of the vacuum cleaner reach its optimum potential creating the best possible cleaning results.

 The use of FilterBags made of paper or a similar material, or FilterBags with a cardboard retaining plate can lead to serious damage to the vacuum cleaner and possibly voiding the warranty, just as with the use of filter bags without the "Original Miele" logo.

Purchasing new FilterBags and filters

Original Miele FilterBags and filters can be purchased from an authorized Miele vacuum dealer or by visiting the Miele store at <http://store.miele.com>.

Which FilterBags and filters are the right ones?

This vacuum cleaner uses Original Miele FilterBags Type **U** and Original Miele filters, the "Original Miele" Logo will appear on the packaging or directly on the FilterBag.



An "AirClean" exhaust filter and a dust compartment filter are supplied with every box of Miele filter bags.

If you would like to purchase additional Miele filters separately, contact your vacuum dealer or Miele, please quote the model number of your Miele vacuum cleaner to ensure correct parts are ordered. These parts are also available to order from the online Miele store.

The exhaust filter supplied with the vacuum cleaner can be exchanged with another type of Original Miele filter (see "Exchanging exhaust filters").

When to change the FilterBag (see fig. 25)

Change the FilterBag when the colored marker in the airflow indicator fills the display.

Miele FilterBags are disposable and made to be used only once. Do not attempt to reuse.

Check the airflow indicator

- Place the body of the vacuum cleaner into the full upright position.
- Use the On/Off button on the handle to switch the vacuum cleaner on, then select the highest suction setting.
- Tip the vacuum cleaner until you can read the color marker in the indicator window. The electrobrush will be lifted up at the front.

If the color marker completely fills the indicator window, the FilterBag needs to be changed.

How the airflow indicator works

The airflow indicator is designed to show when the bag is full of common household dust. It also measures the amount of air flow through the FilterBag. Normal household dust is a mixture of dust, hair, carpet fluff, threads, etc.

However, if fine dust, such as drill dust, sand, plaster or flour is vacuumed, the pores of the FilterBag may become blocked. The marker will indicate that the bag is "full" even though it does not look "full". The FilterBag should still be changed, as the suction power is greatly reduced.

If the bag is bulging with pet fur, hair, carpet fluff, etc. the indicator may not register "full". This is because the air flow of the FilterBag may still be high enough not to activate the marker to show maximum. The FilterBag should still be changed.

Changing the FilterBag (see fig. 26, 27 + 28)

- Place the body of the vacuum cleaner into the full upright position.
- Lift the release button for the dust compartment lid and open until it clicks into place.
- Pull the tab on the collar and swing the FilterBag up and away from the suction socket before taking it out of the frame.

The FilterBag has a flap that automatically closes to prevent dust from escaping when the bag is removed.

- Do not unfold the FilterBag when you first remove it from the box. Insert the new FilterBag as far as it will go into the holder.
- Unfold the FilterBags in the dust compartment.
- Close the dust compartment lid until it clicks into place, taking care not to catch the FilterBag in the lid. The FilterBag is automatically aligned with the vacuum hole.

 An empty-operation-barrier blocks the dust compartment lid from closing if no FilterBag is inserted or if it is not inserted correctly. Do not force it closed.

When to change the dust compartment filter (pre-motor filter)

Whenever you start a new box of Miele FilterBags, you should change the dust compartment filter. A new filter is included in every box.

Changing the dust compartment filter (see fig. 29)

- Open the dust compartment lid.
- Open the filter frame, use the clean corner to remove the filter.
- Insert a new filter.
- Close the filter frame.
- Close the dust compartment lid until it clicks into place.

When to change the exhaust filter

Depending on the model, your vacuum cleaner will use one of the following exhaust filters (see fig. 2):

a AirClean Filter

Whenever you start a new box of Miele FilterBags, you should change this exhaust filter. A new AirClean exhaust filter is included in every box of Miele FilterBags.

b Active AirClean Filter SF-AA 30 (black) c HEPA AirClean Filter SF-HA 30 (white)

If the display of the exhaust filter change indicator has turned fully red (see fig. 7).

The indicator light will come on after approx. 50 hours of operation, which is equivalent to one year of average use. The vacuum cleaner can still be used however, the filter performance and suction power will be reduced.

Be sure to have a replacement filter on hand.

Replacing the "AirClean" filter (see fig. 30, 31 + 32)

Do not use more than one filter at a time.

- Open the exhaust filter compartment lid.
- Remove the filter frame.
- Open the filter frame and use one of the two clean corners to remove the used AirClean filter.
- Insert a new AirClean filter.

If you wish to replace the AirClean filter with an Active AirClean 30 filter or HEPA AirClean 30 filter see "Maintenance and care - Exchanging exhaust filters".

- Close the filter frame and insert it back into the compartment.
- Close the exhaust filter compartment lid.

Replacing the "Active AirClean 30" filter and the "HEPA AirClean 30" filter (see fig. 33)

Do not use more than one filter at a time.

- Open the exhaust filter compartment lid.
- Remove the exhaust filter.
- Insert the new exhaust filter and press the exhaust filter change indicator ► (see fig. 5).

After about 10-15 seconds, a small red marker will appear in the left-hand side of the display (see fig. 6).

- Close the exhaust filter compartment lid.

If you wish to use an Air Clean filter see "Exchanging exhaust filters".

Exchanging exhaust filters

Depending on the model, your vacuum cleaner will use one of the following standard exhaust filters (see fig. 2):

- a** AirClean
- b** Active AirClean 30 (black)
- c** HEPA AirClean (white)

If you wish, you can use one of the alternative filters instead of the standard filter supplied with your appliance. Each filter offers different characteristics (see section "Optional accessories").

Important

1. If you replace exhaust filter **a** with exhaust filter **b** or **c**, you must be sure to remove the filter frame before inserting the new filter type. The exhaust filter change indicator must also be activated (see fig. 5).
2. If you replace exhaust filter **b** or **c** with exhaust filter **a**, be sure to place the new filter in a filter frame * (see fig. 31).

Do not use more than one filter at a time.

* Filter frame - see "Optional accessories"

Service indicator with reset button (see fig. 34)

The indicator light will come on after approx. 50 hours of operation, which is equivalent to one year of average use. Check if the motor protection filter and the exhaust filters need to be replaced as well. You will need to reset the indicator after replacing any of these components.

To do this, the vacuum cleaner must be turned on.

- Press the reset button .

The service indicator will go out and be reset to its original position.

The reset feature only works properly if the indicator light has already come on, but not if the reset button is pressed in between filter changes.

Removing hair and threads from the Powerbrush (see fig. 35)

- Turn off the vacuum and unplug it from the outlet.
- Release the body of the vacuum cleaner and lower it to the floor (see fig. 12).
- Turn the vacuum cleaner over.
- Use scissors to cut any threads or hair that have wound around the roller brush. Guide the scissors along the guide track on the beater bar.

The trimmings will be drawn into the vacuum cleaner by the suction once the vacuum cleaner is turned on.

Blockages (see fig. 36 + 37)

If there are large particles or other blockages at the base of the suction hose, you can open it up to clear the passage.

- Click the vacuum cleaner into the full upright position.
- Press the release button on the telescopic wand and remove the handle from the suction hose
- Guide the swivel elbow at the end of the suction hose over the catch hooks, to increase the stability the vacuum cleaner (see fig. 21).

① Undo the suction hose in the direction of the arrow.

② Pull the suction hose connector off the swivel elbow.

- Remove all blockages
- Put the connector back on and click it shut.

If you still have not been able to remove the obstruction(s), there is another method you can try.

Open the service flap on the bottom rear of the vacuum cleaner.

① Use a coin to undo the two screws until they stop.

② Pry the service flap free.

- Remove all blockages.

Put the service flap back on and screw into place.

Cleaning and care

Cleaning

 Turn the vacuum cleaner off and unplug it from the outlet before performing any maintenance work.

Vacuum cleaner and accessories

The vacuum cleaner and all plastic accessories can be cleaned using a damp cloth and a cleaner suitable for plastics.

 Do not use abrasive, oil-based, glass or all purpose cleaners!

Dust compartment

If the dust compartment needs to be cleaned, use another vacuum cleaner, a dry cloth or dusting brush.

 Do not submerge the vacuum cleaner in water. If moisture gets into the appliance, there is the risk of electric shock.

Frequently asked questions

What if the vacuum cleaner automatically shuts off?

ComfortLine Models:

The "On" indicator lights red.

PremiumLine Models:

The "⚠" Thermo indicator lights red.

A temperature sensor will turn off the vacuum cleaner if it becomes too warm. This problem can occur if, for example, an object is blocking the suction tube or the FilterBags pores have become clogged with fine dust. The cause could also be a heavily soiled exhaust or dust compartment filter.

If this happens, turn off the vacuum cleaner and the Powerbrush and unplug the power plug from the electrical outlet.

Once the cause has been addressed, allow the vacuum cleaner to cool for approx. 20 - 30 minutes before resuming vacuuming.

What if the Powerbrush automatically shuts off and the indicator displays a red light?

The blockage protection feature has been activated. This can occur if enough threads wrap around the beater bar or if a large or long object has been vacuumed up.

If this happens, turn off the Powerbrush, then switch off and unplug the vacuum cleaner.

Once the blockage has been removed, the vacuum cleaner is ready for use.

What if the Powerbrush automatically shuts off and the indicator displays a yellow light?

The temperature limiter in the Powerbrush has been triggered because of overheating, for example due to a blockage in the vacuum hose/wand.

If this happens, turn off the Powerbrush, then switch off and unplug the vacuum cleaner.

Once the vacuum hose/wand and all filters have been inspected, plug in the vacuum cleaner and turn it on and vacuum for approx. 10 minutes (leave the Powerbrush on). This helps cool off the Powerbrush so that it can be switched on again.

After sales service

In the event of a fault which you cannot fix yourself please contact the Miele Service Department at the phone number listed on the back of this booklet.

- Please quote the model type of your appliance.

This can be found on the data plate on the bottom of the Powerbrush

Optional accessories

Some models come with the one or more of the following accessories.

Always follow the flooring manufacturer's cleaning and care instructions.

You can order these and many other products via the Miele website.

Attach the desired accessory onto the handle of the vacuum hose or onto the telescopic wand or onto the EasyLock wand (depending on model).

Turbo/Floor brushes

Hand Turbobrush Turbo Mini / Turbo Mini Compact (STB 101 / STB 20)

For vacuuming upholstery, mattresses or car seats.

Floor brush Hardfloor (SBB 235-3)

To vacuum sturdy hard floors, e.g. tiles.

Floor brush Parquet

With natural bristles for use on hardwood-type floors that may be susceptible to scratching, such as parquet and laminates.

Floor brush - Parquet Twister with swiveling head (SBB 300-3)

For vacuuming all hard flooring and tight spaces.

Floor brush - Parquet Twister XL with swiveling head (SBB 400-3)

For vacuuming large areas of hard flooring and tight spaces.

Other accessories

Accessory case MicroSet (SMC 20)

Accessories for use on small or hard-to-reach items (stereos, keyboards, models, etc).

Universal brush (SUB 20)

For dusting books, shelves etc.

Radiator brush (SHB 30)

(must be used in connection with the crevice nozzle)

For cleaning radiators, narrow shelves and crevices.

Mattress tool (SMD 10)

For use on mattresses, upholstery, and deeper crevices.

Upholstery nozzle, 7 1/2" (190 mm) (SPD 10)

Extra wide upholstery nozzle for cleaning upholstered furniture, mattresses and pillows.

Filter

Filter frame

The filter frame is needed if you would like to exchange the ActiveAirClean 30 or HEPA AirClean 30 filters with the Air Clean filter (see "Exchanging exhaust filters").

ActiveAirClean 30 exhaust filter (SF-AA 30)

This special active charcoal filter absorbs odors collected in the FilterBag. The filter effectively controls most odors. The ActiveAirClean 30 filter can be exchanged with the existing exhaust filter.

HEPA AirClean 30 filter (SF-HA 30)

Vacuum cleaners equipped with this exhaust filter are particularly suitable for allergy sufferers and those concerned with a high level of hygiene because of its ability to trap respirable particles and allergens.

Caring for the environment

Disposal of the packing material

The cardboard box and packaging protect the vacuum cleaner during shipping. These materials are recyclable. Please recycle.

Ensure that any plastic wrappings, bags etc. are disposed of safely and kept out of the reach of children. Danger of suffocation!

Disposal of an old machine

Old vacuum cleaners may contain materials that can be recycled. Please contact your local recycling authority about the possibility of recycling these materials.

What This Warranty Covers And For What Period The Coverage Extends

Miele, Inc. (hereinafter "Miele") warrants to the original purchaser of this product, living in the United States of America, who purchased their vacuum from a Miele authorized distributor or dealer:

- a. That this product, including all of its Miele authorized parts is free of defects in material and workmanship.
- b. That this product, if found to be defective within the stated warranty period, will be repaired free of charge to the consumer (both parts and labor) by an authorized Miele service agent.
- c. The warranty period for vacuum cleaners (excepting the S8990 and RX1 Scout), and all accessories, excluding vacuum cleaner motors, power head motors, and vacuum cleaner casings (body), is one (1) year from the date of purchase. For the S8990, the warranty period is five (5) years from the date of purchase.
- d. For vacuum cleaner casings (body), the warranty period will be as follows:
 - The structural integrity of the vacuum cleaner casing (body), will be covered for seven (7) years from the date of purchase against defects in material and workmanship on the S2xxx, S4xxx, S5xxx, S6xxx, S7xxx, S8xxx, S160 and S190 product series.
 - The structural integrity of the vacuum cleaner casing (body) of the S8990 will be covered for ten (10) years from the date of purchase against defects in material and workmanship.
- e. For vacuum cleaner and power head motors, the warranty period will be as follows:
 - Vacuum cleaner and power head motors will be covered for seven (7) years from the date of purchase on the S2xxx, S4xxx, S5xxx, S6xxx, S7xxx, S8xxx, S160 and S190 product series.
 - Vacuum cleaner and power head motors for the S8990 will be covered for ten (10) years from the date of purchase.
- f. For the RX1 Scout, the warranty period is two (2) years from the date of purchase for the complete vacuum, except for the battery, which will be warranted for one (1) year from the date of purchase.

Vacuum cleaners other than the RX1 Scout used for commercial purposes, except for their motors, will be warranted for a period of six (6) months from the date of purchase. The motors of commercially used upright vacuums will be warranted for one (1) year and the motors of all other commercially used vacuum cleaners, except for the RX 1 Scout will be warranted for two (2) years. There is no warranty for the RX1 Scout used for commercial purposes. Thereafter this Limited Warranty shall be null and void.

This warranty only applies while the product remains within the United States, and shall be null and void in any other US territories, possessions, or foreign countries.

What is not covered by this Warranty

This warranty does not cover damage or defects caused by or resulting from repairs, service or alterations to the product or any of its parts or accessories which have been performed by service centers or repairmen not authorized by Miele, or damage or defects caused by negligence, accident, abuse, misuse, improper or abnormal usage or maintenance of the product, its parts or accessories. Ordinary wear and tear or cosmetic damage (scuffs, scratches, gouges, dents, etc.) shall not be considered a defect in materials or workmanship.

Exclusion of Other Warranties

Except for the limited warranty provided herein, Miele disclaims any and all other express warranties with respect to the product. Any warranty of merchantability or fitness for a particular purpose is limited in its duration to the term of the limited warranty provided herein. Some states do not allow limitations on how long an implied warranty lasts, so the above limitation may not apply to you.

Limitation of Liability for Special, Incidental or Consequential Damages

Miele will assume no liability, or other obligation with respect to any personal injury or property damage resulting from the use of a vacuum cleaner, or its accessories, replacement parts, etc., which has not been purchased from, or serviced by an Authorized Miele Dealer. Any purchaser who obtains a vacuum cleaner, accessories, replacement parts, etc., from someone other than an Authorized Miele dealer proceeds at their own risk.

Miele specifically disclaims any and all liability, whether directly or by way of indemnity, for special incidental, consequential or other damages, whether based on breach of contract, tort, strict or product liability, or any other legal theory. Some states do not allow the exclusion or limitation of incidental or consequential damages, so the above limitation may not apply to you.

Special State Laws

This Limited Warranty gives you specific legal rights; you may have other rights, which vary, from state to state.

Service

For service under this Limited Warranty, or for information you may need about the product, please contact Miele at the US address listed on the back of this booklet, or visit us at www.mieleusa.com.

Authorized Miele Dealers

To find an authorized Miele dealer in your area, please visit our website at www.mieleusa.com.

Effective Date: June 1, 2014

©2014 Miele, Inc.

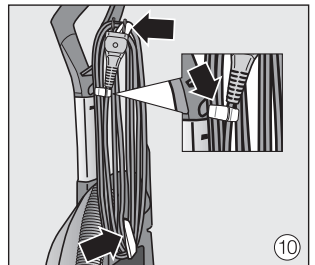
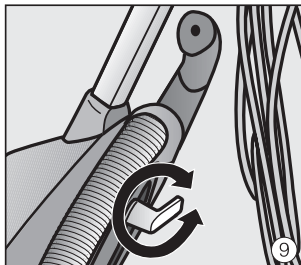
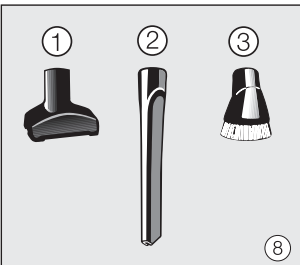
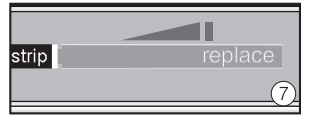
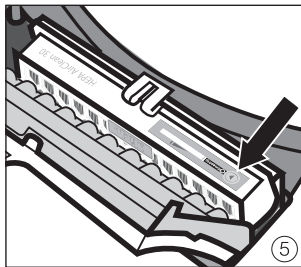
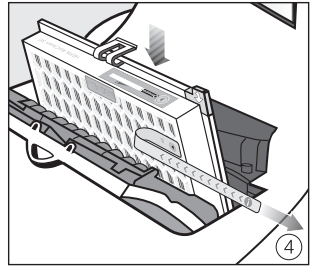
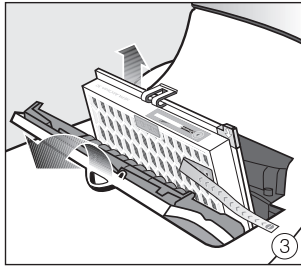
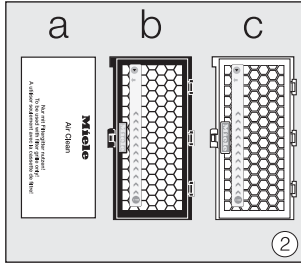
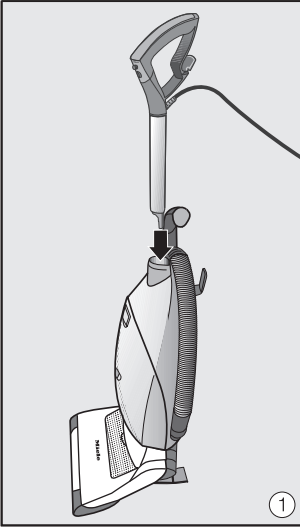

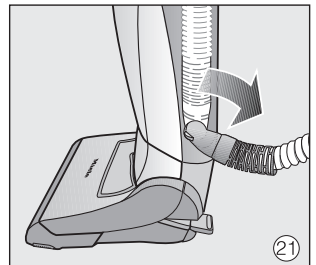
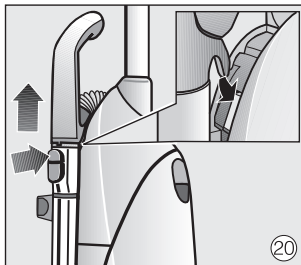
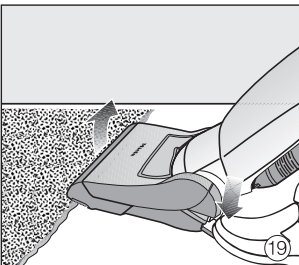
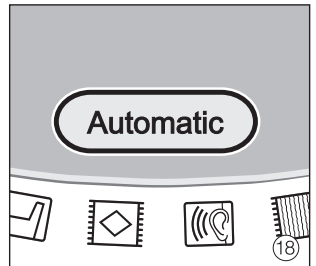
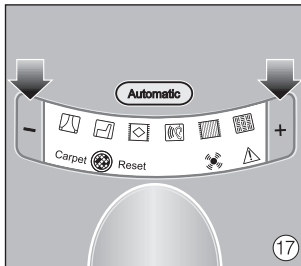
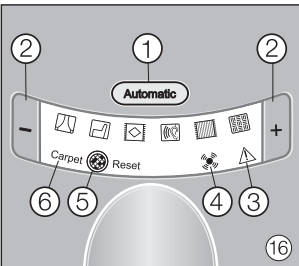
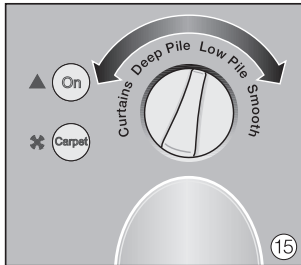
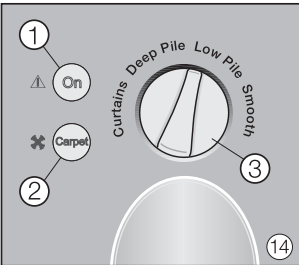
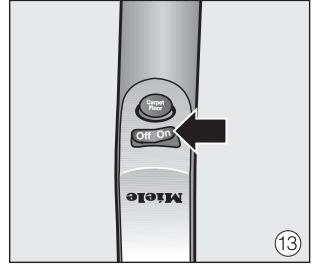
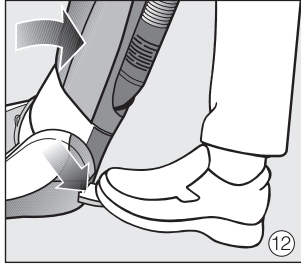
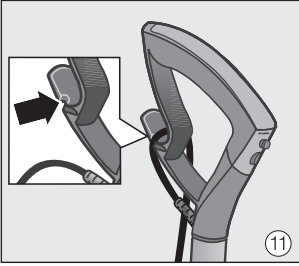

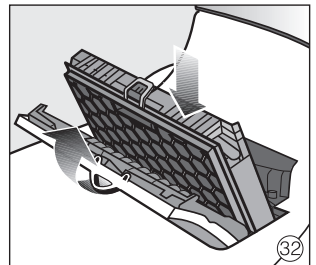
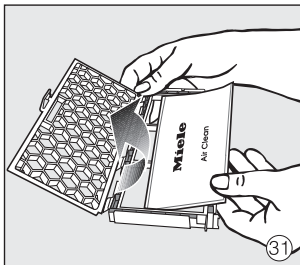
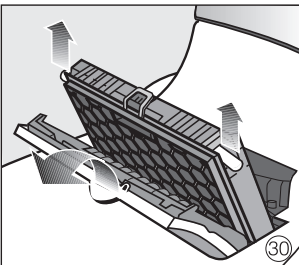
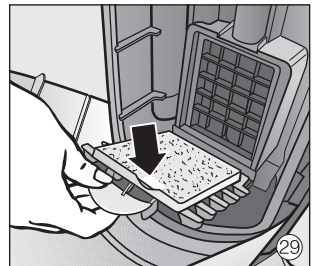
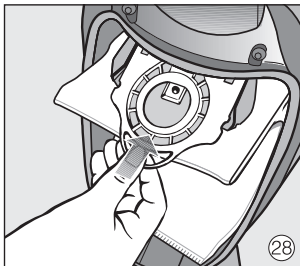
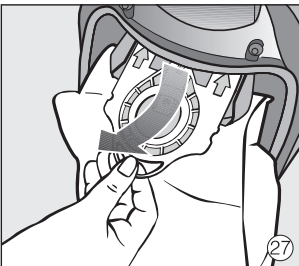
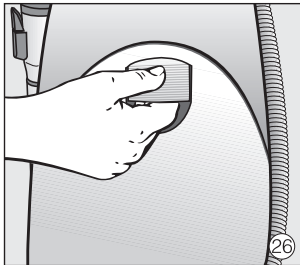
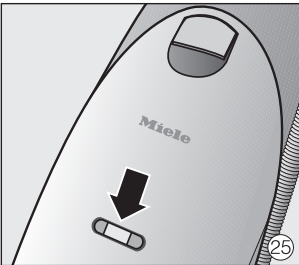
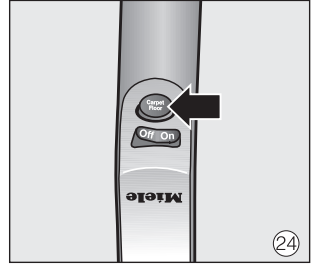
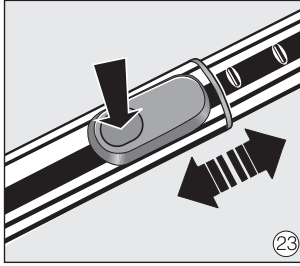
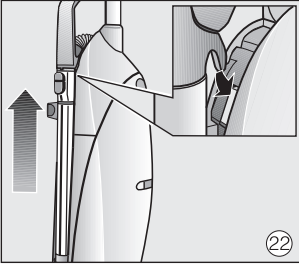

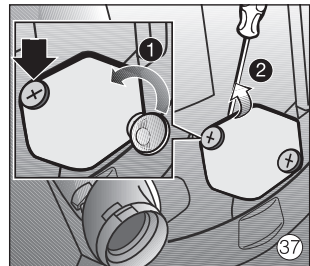
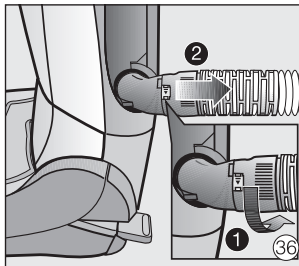
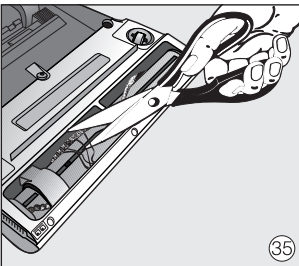
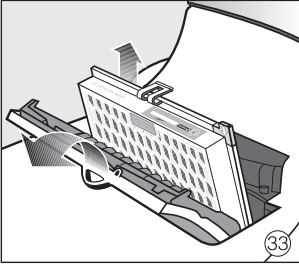

Please have the model and serial number
of your appliance available before
contacting Technical Service.

Miele

U.S.A.

Miele, Inc.

National Headquarters

9 Independence Way
Princeton, NJ 08540
Phone: 800-843-7231
609-419-9898
Fax: 609-419-4298
www.mieleusa.com

Technical Service & Support Nationwide

Phone: 800-999-1360
Fax: 888-586-8056
TechnicalService@mieleusa.com



Canada

Importer
Miele Limited

Headquarters and Miele Centre

161 Four Valley Drive
Vaughan, ON L4K 4V8
www.miele.ca

Customer Care Centre

Phone: 800-565-6435
905-532-2272
customercare@miele.ca

Germany

Manufacturer
Miele & Cie. KG
Carl-Miele-Straße 29
33332 Gütersloh